



## TL1250P-850V N6 CS 4K Resolution Day/Night lens for 1/1.7\"/>

- ✓ Ultra high resolution for 4K cameras, up to 12.4 megapixel, 300 lp/mm
- ✓ P-iris (stepper motor) for precise aperture control
- ✓ Fully motorized with zoom, focus, iris, IR cut, and limit switches
- ✓ Optional motor control board (MCR600 or MCR400) available for easy integration
- ✓ IR corrected for true Day/Night cameras
- ✓ Compact design to fit into domes as small as 4\"/>
- ✓ CS-mount
- ✓ Used for sensor sizes 1/2.5\", 1/2.3\", 1/2\", 1/1.8\", and up to 1/1.7\"/>

### TL1250 lens specifications

Focal length (FL)	12-50mm
Mount type	CS-mount
Iris type	P-iris
Image circle	Ø9.4mm at FL 12mm
Resolution	12.4 megapixel, 300 lp/mm
F/#	F/1.8 @ 12mm - F/2.4 @ 50mm to close
IR Correction	435nm – 940nm (Day/Night)
Focus Range	2.0m - infinity
Lens length (TTL)	64mm TTL
Back focal length (BFL)	8.2mm (in air)
Chief ray angle (CRA)	< 7°
Geometric distortion	< 10% at 12mm, < 2% at 50mm
Relative illumination	>40%
Lens transmission	>80%
Weight	74g
Operating temperature	-20C to 60C (<70% humidity, non-condensing)
Storage temperature	-30C to 70C (<90% humidity, non-condensing)

### Field of view for sensor sizes (12mm – 50mm)

Sensor size	1/1.7\"/> <th>1/1.8\"/&gt; <th>1/1.8\" 4K*</th> <th>1/2\"/&gt; <th>1/2.3\"/&gt; <th>1/2.5\"/&gt; </th></th></th></th>	1/1.8\"/> <th>1/1.8\" 4K*</th> <th>1/2\"/&gt; <th>1/2.3\"/&gt; <th>1/2.5\"/&gt; </th></th></th>	1/1.8\" 4K*	1/2\"/> <th>1/2.3\"/&gt; <th>1/2.5\"/&gt; </th></th>	1/2.3\"/> <th>1/2.5\"/&gt; </th>	1/2.5\"/>
Horizontal	36° - 8.6°	36° - 8.6°	35° - 8.5°	30° - 7.4°	30° - 7.2°	27° - 6.7°
Vertical	26° - 6.5°	23° - 5.8°	17° - 4.3°	23° - 5.6°	22° - 5.5°	20° - 5.0°
Diagonal	46° - 11°	44° - 10°	40° - 9.5°	39° - 9.2°	38° - 9°	34° - 8.3°

\*4K format = 4000 x 2000 pixels



## Lens drawing

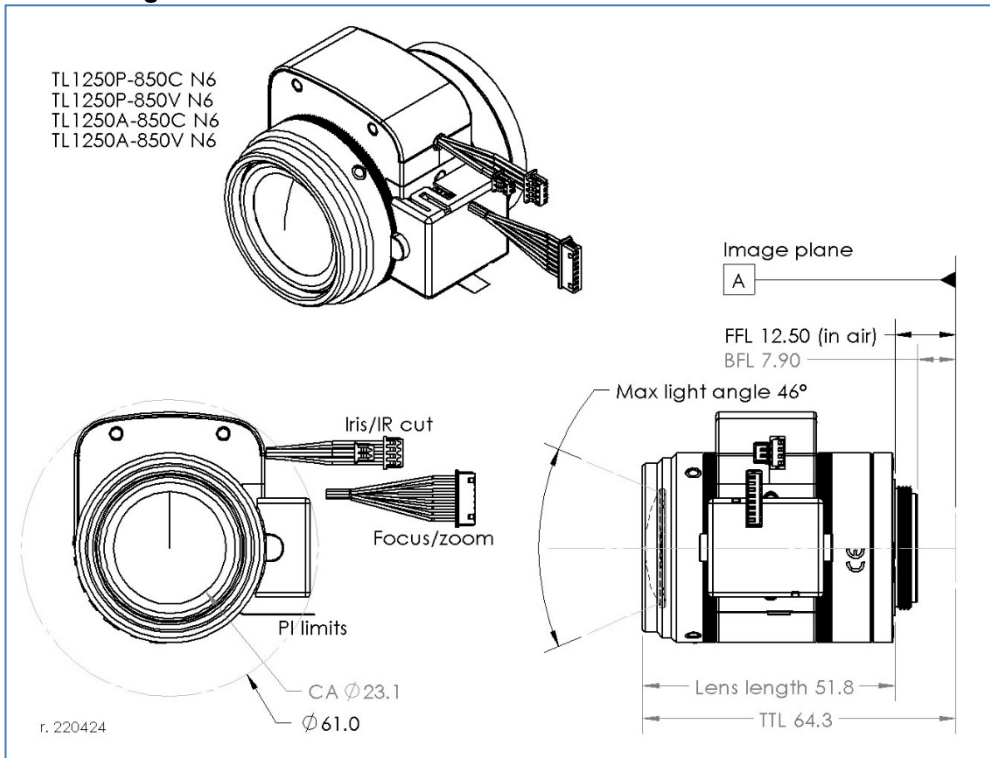

CAD models can be downloaded from [TheiaTech.com/1250CAD](http://TheiaTech.com/1250CAD)

## Entrance pupil location

The entrance pupil location is located inside the lens and for the longer focal length, even behind the image sensor position. It is measured from the vertex of the lens at the input side. The lens vertex is 0.5mm below the plastic front ring of the lens.

Focal Length	Entrance Pupil Location (mm)
12	26.35
15	31.88
20	43.18
25	52.97
30	61.65
35	69.40
40	76.08
45	81.49
50	89.85

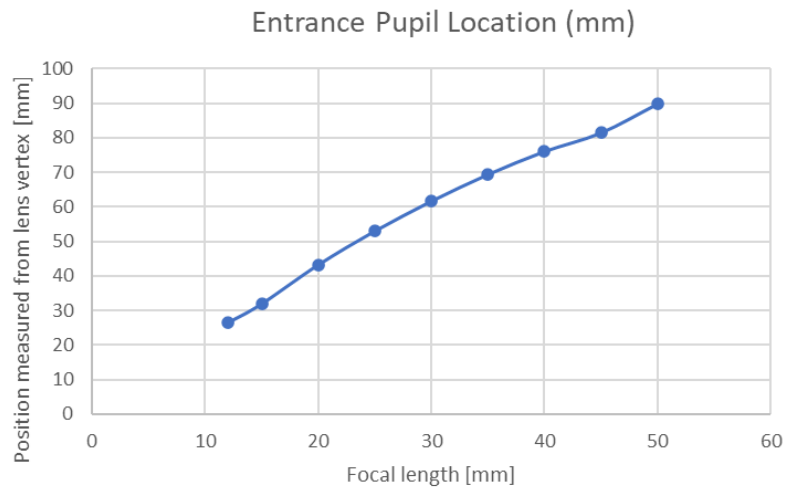

## Zoom/Focus motor specifications

Drive	Stepper motor 2 phase bipolar drive
Operation voltage	3.3V (2.5-3.5V range)
Maximum motor temperature*	Do not let motor temperature exceed 120°C
Coil resistance	30.0Ω
Zoom number of steps	3227 steps between hard stops
Zoom speed range**	Up to 1200pps
Zoom cam rotation	75°
Focus number of steps	8390 steps between hard stops
Focus speed range**	Up to 1200pps
Focus cam rotation	195°
Focus/zoom connectors	Housing: Molex 51021-0800 Terminal: Molex 50058-8000
Cable length	150mm

Zoom: Wide -> Tele				
Focus: Near -> ∞				
Step	A+	A-	B+	B-
0	H	L	H	L
1	L	H	H	L
2	L	H	L	H
3	H	L	L	H

Pin	Color	Function	Motor
1	Brown	A+	Focus
2	Red	A-	Focus
3	Orange	B+	Focus
4	Yellow	B-	Focus
5	Brown	A+	Zoom
6	Red	A-	Zoom
7	Orange	B+	Zoom
8	Yellow	B-	Zoom

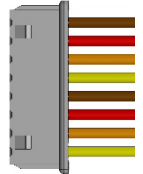

\*Theia's motor temperature calculator can be used to estimate the focus and zoom motor temperatures after a set number of run/ cool down cycles. This can be downloaded from Theia's website (see the QR code below). These motorized lenses are **not intended for continuous use** of the motors as in PTZ applications due to potential over-heating of the lens motors.

The example below shows 60C ambient temperature and 3.5V motor. The motor is driven for 30 seconds (which would generally be longer than normal) with 10 seconds cool down between moves. After 3 moves, the motor is allowed to cool down which takes about 3 minutes.

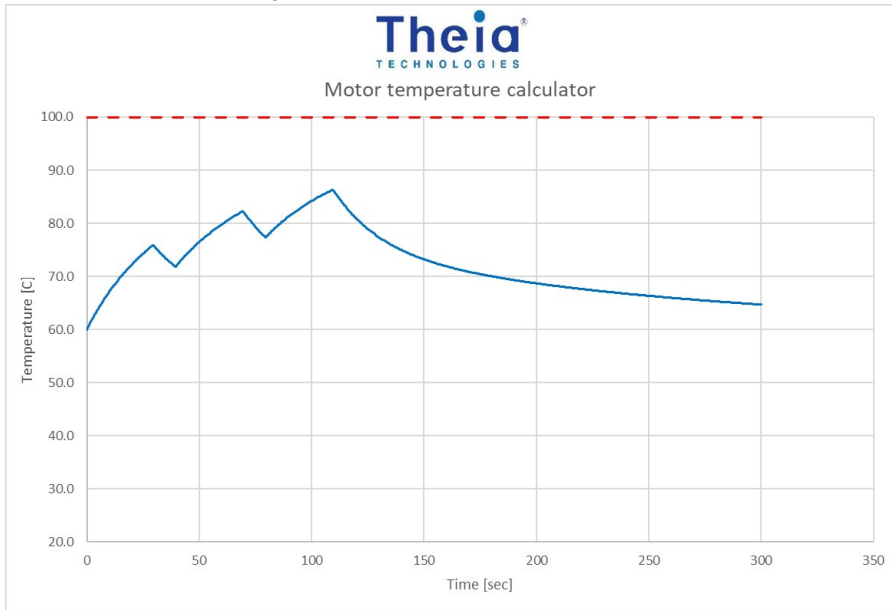

Motor temperature calculator  
[TheiaTech.com/calculators](https://TheiaTech.com/calculators)

\*\*Zoom and focus motor positions may be affected by backlash and lost steps during movement. Lost steps are affected by the driving conditions. It is best to drive the motor between 200pps and 1200pps with 4-12 steps of acceleration/deceleration. Acceleration is especially helpful at higher driving speeds. Within these limits, the lost steps should be <5 steps per full zoom/focus range.

Backlash is variable from lens to lens but should be consistent for each movement of the lens motors. For zoom, expected backlash is approximately 15-20 steps and for focus it is approximately 30-40 steps.

Zoom/Focus motor key steps.

<i>Zoom motor</i>		<i>Focus motor</i>	
<i>Note</i>	<i>Step</i>	<i>Note</i>	<i>Step</i>
Hard stop (wide)	3227	Hard stop (far)	8390
Wide design position	3227		
PI position	3119	PI position	7959
Tele design position	0		
Hard stop (tele)	0	Hard stop (near)	0

Zoom/Focus synchronizing map (observe min/max motor speeds). Due to internal lens variations and back focal length variations in the camera the observed focus motor step will be different than the design position shown below. The motor positions should be calibrated at several zoom/focus positions so these calibrated values can be used to offset the design curve at the set focal lengths to find the corrected zoom/focus curve for the lens.

<i>Focal length</i>	<i>Zoom motor note</i>	<i>Zoom motor step number</i>	<i>Focus motor step number</i>
<i>[mm]</i>		<i>[#]</i>	<i>[#]</i>
12.36	Wide end	3227	3008
14.83		2710	2117
18.05		2194	1356
22.28		1678	895
27.86		1161	1046
35.20		645	2413
49.00	Tele end	0	8067

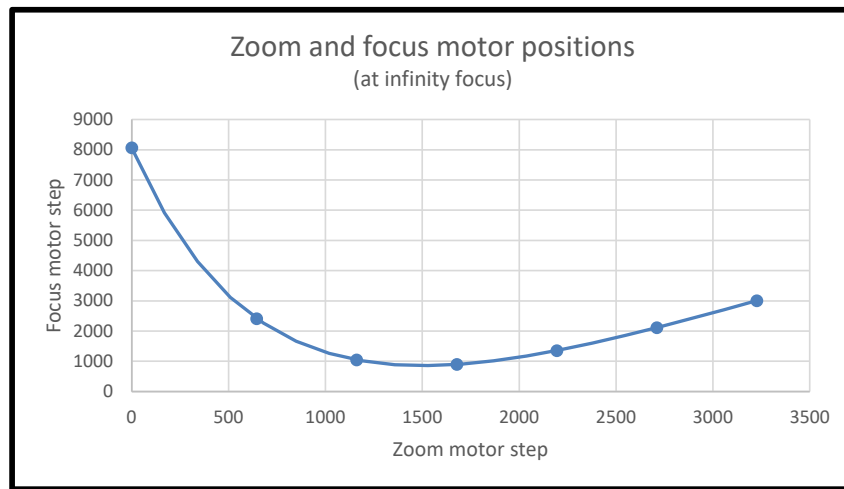

**Notes:**

These motorized lenses are intended for integration into cameras and require motor drivers and controllers. Typically, Theia works with the camera manufacturer to ensure that the camera motor controller matches the lens. It is possible to supply your own motor controller, but Theia cannot guarantee that your motor controller will not damage the lens. Theia does not offer any warranty on the suitability of these motorized lenses for any particular camera. Theia offers motor control boards that are suitable to control motorized lenses with P-iris.

## P-iris motor specifications

Drive	Stepper motor 2 phase bipolar drive
Operating voltage	4V (+/-1)
Number of steps	75 (open to closed)
Basic step angle	18°
Maximum response freq.	200pps
Coil resistance	30Ω

P-iris: open->close				
Step	A+	A-	B+	B-
0	H	L	H	L
1	L	H	H	L
2	L	H	L	H
3	H	L	L	H

### Connector type 1 (Molex)

Connector type	Housing: Molex 51021-0400 Terminal: Molex 50058-8000
Cable length	150mm

Pin	Color	Function
1	Brown	B+
2	Red	B-
3	Yellow	A+
4	Orange	A-

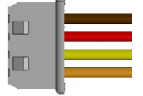

## P-iris motor map

Step	Aperture Size [mm <sup>2</sup> ]	F/# (at FL=12mm)
1	95.0	1.84
5	90.8	1.88
10	82.1	1.98
15	72.8	2.10
20	63.4	2.25
25	54.0	2.43
30	44.9	2.67
35	36.0	2.98

Step	Aperture Size [mm <sup>2</sup> ]	F/# (at FL=12mm)
40	27.7	3.39
45	20.0	3.98
50	13.2	4.90
55	7.5	6.52
60	3.1	10.10
65	0.8	19.34
70	0.1	69.29
72	0.0	Closed
75	0.0	Closed

## IR Cut/ selectable optical filter specifications

Electrical specifications	
Drive	DC
Operating voltage	4.0V
Maximum switching time	300ms
Drive coil resistance	130Ω
Connector type	Housing: Molex 51021-0200 Terminal: Molex 50058-8000
Cable length	150mm

Mode	Pin 1	Pin 2
Filter 1	L	H
Filter 2	H	L
Wire color	Red	Black

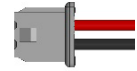

### Filter optical specifications

The lens has 2 internal optical filters which can be selected electronically.

#### Visible bandpass filter

Type	Visible transmission notch filter
Spectrum	405 +/- 10nm: T = 50% 420 – 600nm: T >= 93% ave 650 +/- 10nm: T = 50% 700 – 1000nm: T < 5% max 1000 – 1100nm: T < 10% ave

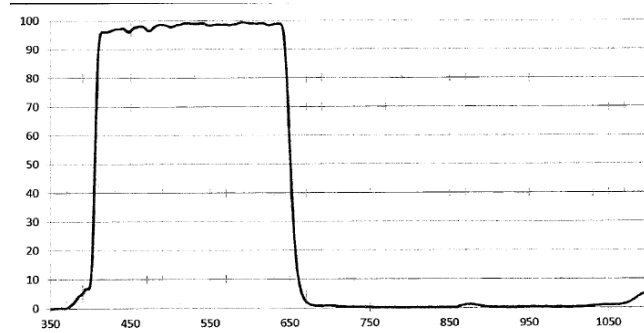

#### IR bandpass filter for 850nm illumination

Type	Notch filter for 850nm illumination
Spectrum	400-700nm : T < 5% ave 820 +/- 10nm: T=50% 850nm: T >= 93% 880 +/- 10nm: T = 50% 900-1050 : T < 5% ave

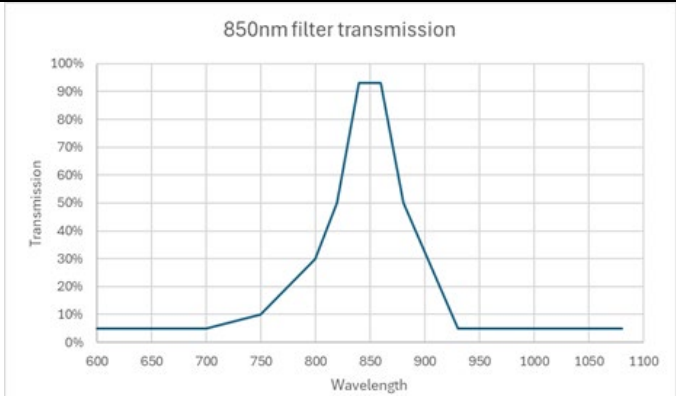

## Zoom/Focus limit switch

Type	Photo interrupter phototransistor
Part model	Sharp GP1S396HCPSF
Operating voltage	3.3V
Output level	>2.2V HIGH <0.6V LOW
Connector type	FPC cable
Board-side mating connector type (not supplied)	Molex 52746-0671 Molex 52745-0697 Molex 52559-0652
Cable length	150mm

Pin*	Function	Motor
1	Emitter	Focus
2	Anode/Collector	Focus
3	Cathode	Focus
4	Emitter	Zoom
5	Anode/Collector	Zoom
6	Cathode	Zoom



\*cable side pin designation matches Molex 52746-0671 bottom side contacts connector  
Recommended circuit for each photo interrupter

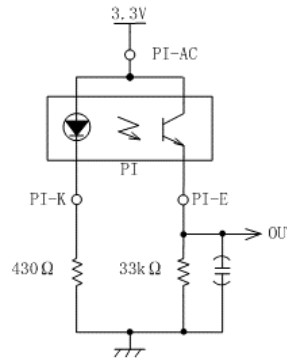

### Alternate lens options

There are other lens configurations. The options listed in the table below may or may not be available. Please visit [www.theiatech.com](http://www.theiatech.com) to learn more about our other lens options.

Theia® PN	Varifocal	Mount type	Mount slip ring	Iris type	CCTV iris con.	Molex iris con.	IR corrected (day/night)	Visible bandpass filter	Clear filter (vis + IR)	850nm bandpass filter	940nm long pass filter	Zoom motor	Focus motor	PI limits	Focal length	MP rating	f/#	Image circle	Biggest sensor format	MOD [m]	Lens Length (to mount)	Lens Length (TTL)	Weight [g]
TL1250P N6-CS	✓	CS	✓	P		✓	✓	✓	✓			✓	✓	PI	12-50	12 (4K)	F/1.8	9.4	1/1.7"	2	52	64.5	74
TL1250P N6-25	✓	25		P		✓	✓	✓	✓			✓	✓	PI									76
TL1250P N5-CS	✓	CS	✓	P	✓		✓					✓	✓	PI									TBD
TL1250P-850V N6-CS	✓	CS	✓	P		✓	✓	✓	✓	✓		✓	✓	PI									74
TL1250P-850C N6-CS	✓	CS	✓	P		✓	✓	✓	✓	✓		✓	✓	PI									74
TL1250P-940V N6-CS	✓	CS	✓	P		✓	✓	✓		✓	✓	✓	✓	PI									74
TL1250P-940C N6-CS	✓	CS	✓	P		✓	✓	✓	✓	✓	✓	✓	✓	PI									74
Related versions without motorized zoom and focus																							
SL1250M	✓	CS	✓	M			✓								12-50	12 (4K)	F/1.8	9.4	1/1.7"	2	52	64.5	65
SL1250P	✓	CS	✓	P	✓		✓																69
SL1250A	✓	CS	✓	A	✓		✓																70

For more information contact

**Theia Technologies**  
info@TheiaTech.com  
[www.TheiaTech.com](http://www.TheiaTech.com)  
+1-503-570-3296

**Revisions:**

<b>Version</b>	<b>Change</b>	<b>Reason</b>
220322	Templated spec sheet	Family spec sheet can be reduced for each lens model to simplify spec sheet
220401	Alternate lens table	Corrected typo, added 2 -N6 versions
	Entrance pupil location	Added dimension for lens vertex relative to lens plastic
220426	Alternate lens table	Updated to delineate non-motorized versions
230110	Corrected TTL	Lens length didn't match drawing
	Added lens weight	Based on first production lenses
	Simplified alternate lens options	Removed -R6 and associated lenses
230124	Reversed FZ curve	Focus steps in FZ curve were reversed from motor moving directions and data in the key positions table
230426	Updated lens table	Added "-CS" to part numbers, general formatting
230605	IRC switching time	Added maximum switch time for IRC
230817	p.4 focus/zoom note	Clarified calibration requirement for focus/zoom curve
240301	850nm filter spec	Spec listed as TBD previously